

## DECK PANELS

### 2024/TOYOTA LAND CRUISER

AC9406701NA

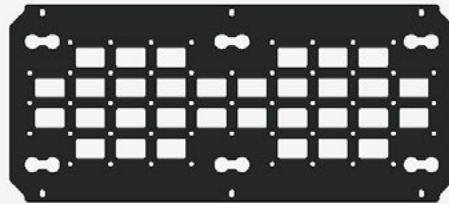
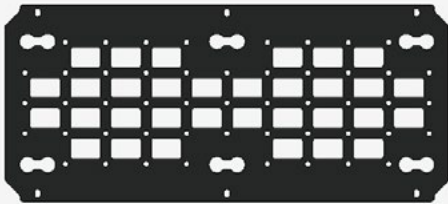

### TOOLS REQUIRED

- 5/32 Allen



### SKILL LEVEL

- Easy



### TIME REQUIRED

- Approximately 20 minutes

## ⚠ WARNINGS/CAUTIONS BEFORE STARTING INSTALLATION ⚠

### -BEFORE YOU INSTALL THIS KIT-

Read and understand all instructions, warnings, cautions, & notes contained in this installation instruction guide. Consult your vehicle owner's manual for proper disconnection of electrical and lifting of vehicle if required for installation of this product.

This install may require some technical skills and knowledge of basic mechanical work. If you do not feel that you are capable of performing this install please take this product to a trained professional.

After reading this guide please contact us with any questions or concerns before installing product.

Customer Service: 830-896-7571  
Rago Fabrication is not responsible for any bodily injury or harm to you or your vehicle as a result of an improper install.

Proper installation of this kit required knowledge of the factory recommended procedures for removal and installation of original equipment components.

We recommend that the factory shop manual and any special tools needed to service your vehicle be on hand during the installation. Installation of this kit without proper knowledge of the factory recommended procedures may affect the

performance of these components and the safety of the vehicle. Inspect all contents of this package to make sure product is not damaged and all installation hardware has been included. If parts are missing from kit, please be prepared to provide the following information:

1. Name of purchase location
2. Bar Code on side of box
3. Date above bar code
4. Date inside box cover

**\*ALWAYS WEAR EYE PROTECTION WHEN OPERATING POWER TOOLS\***

## HARDWARE

**A.**



1/4-20 X 1/2" BUTTON HEAD BOLT

**QTY: 8**

**B.**

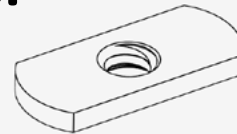

1/4-20" T-NUT

**QTY: 8**

**Reference this page throughout the install**



**AC9406701NA**

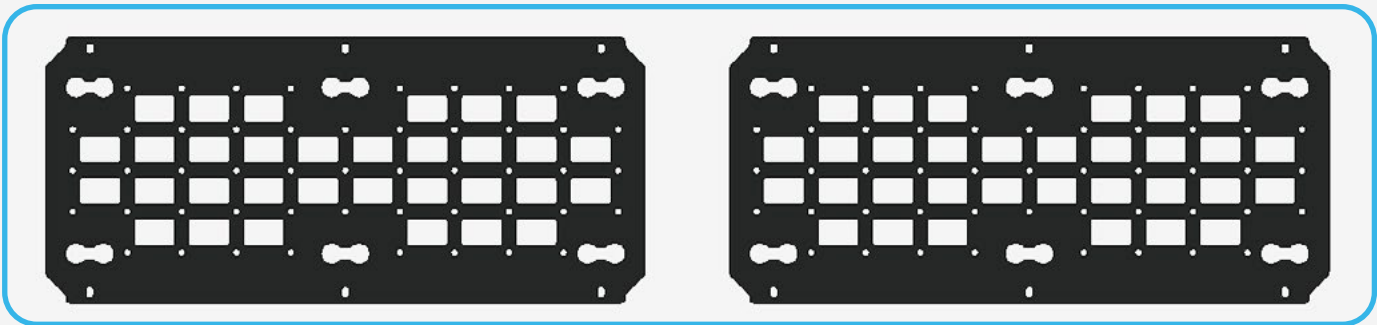
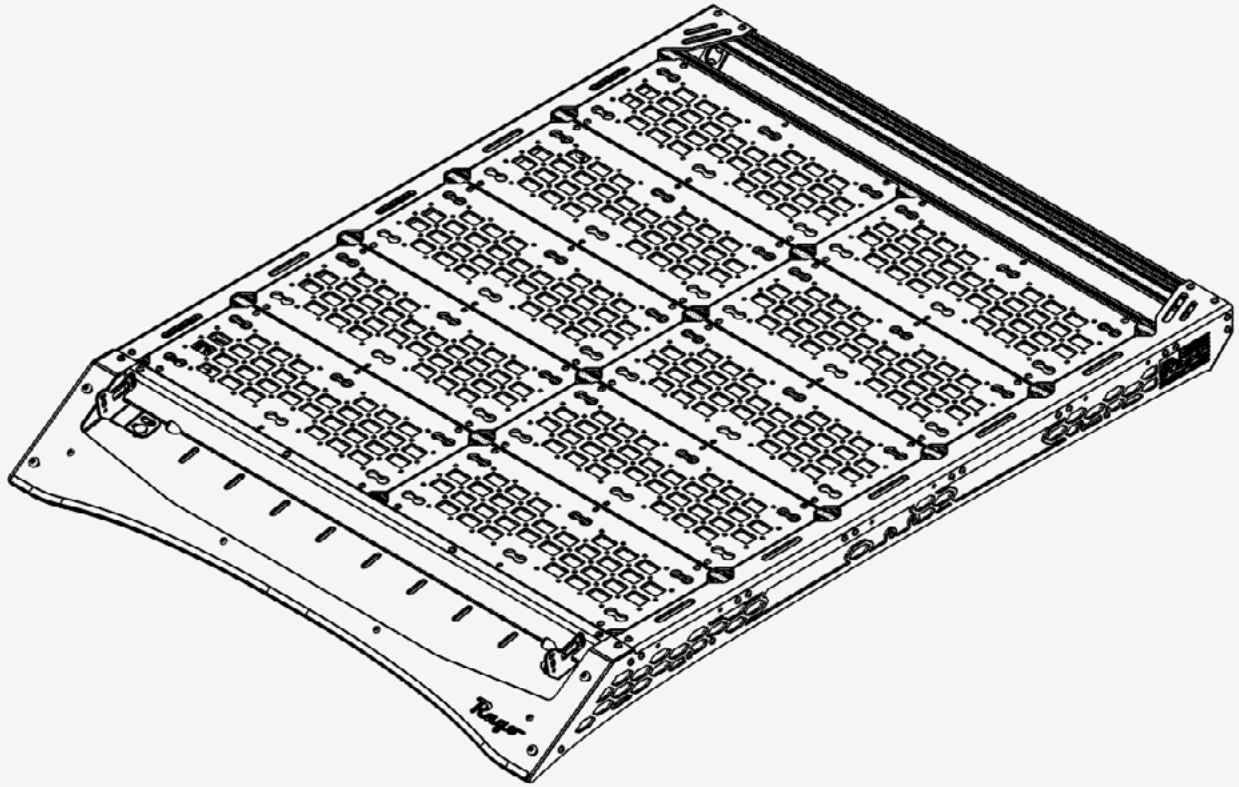

## □ STEP 1

Install **(B)** T-nuts into the slots through the open slot located on one side of the rail.

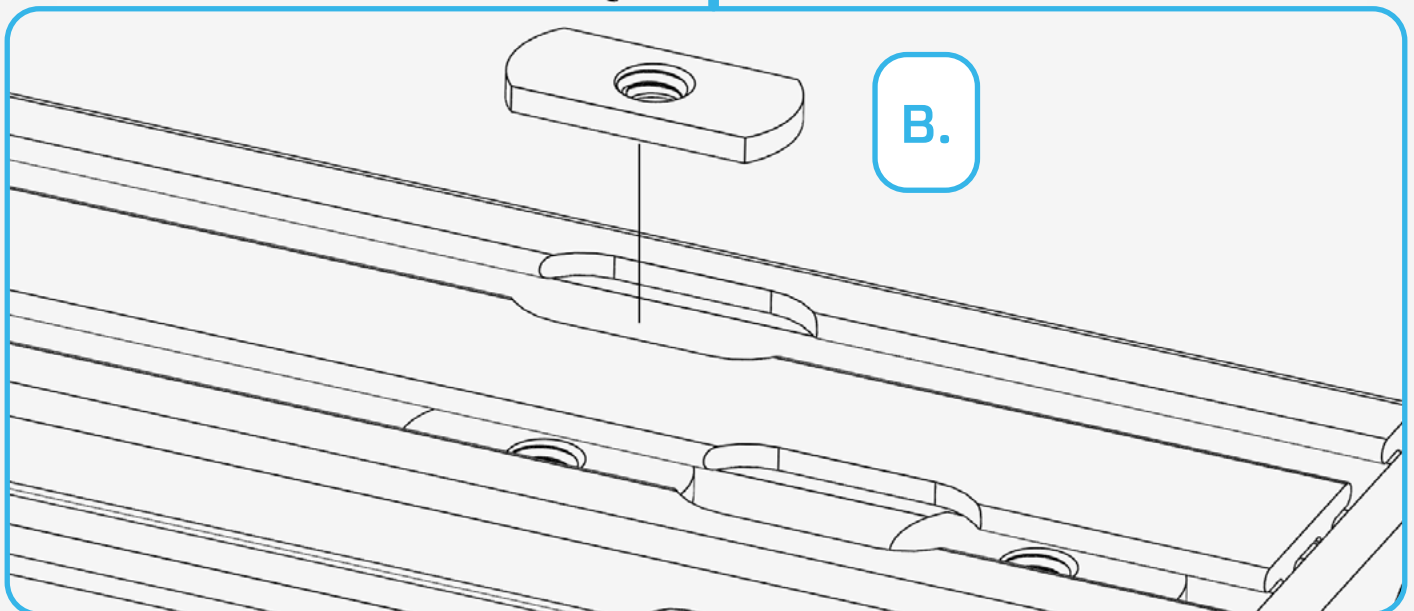
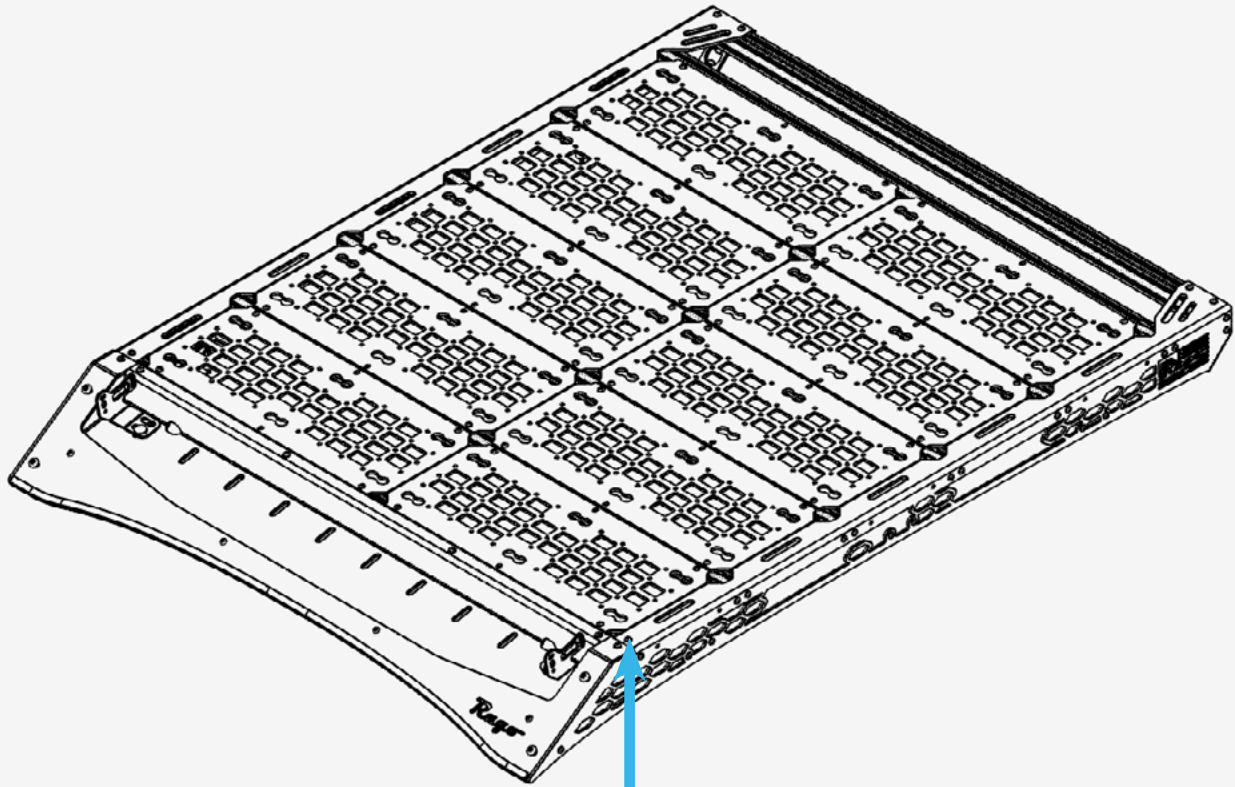

## □ STEP 2

Using a (5/32 allen) install the deck panels to the roof rack with the provided (A) 1/4" hardware.

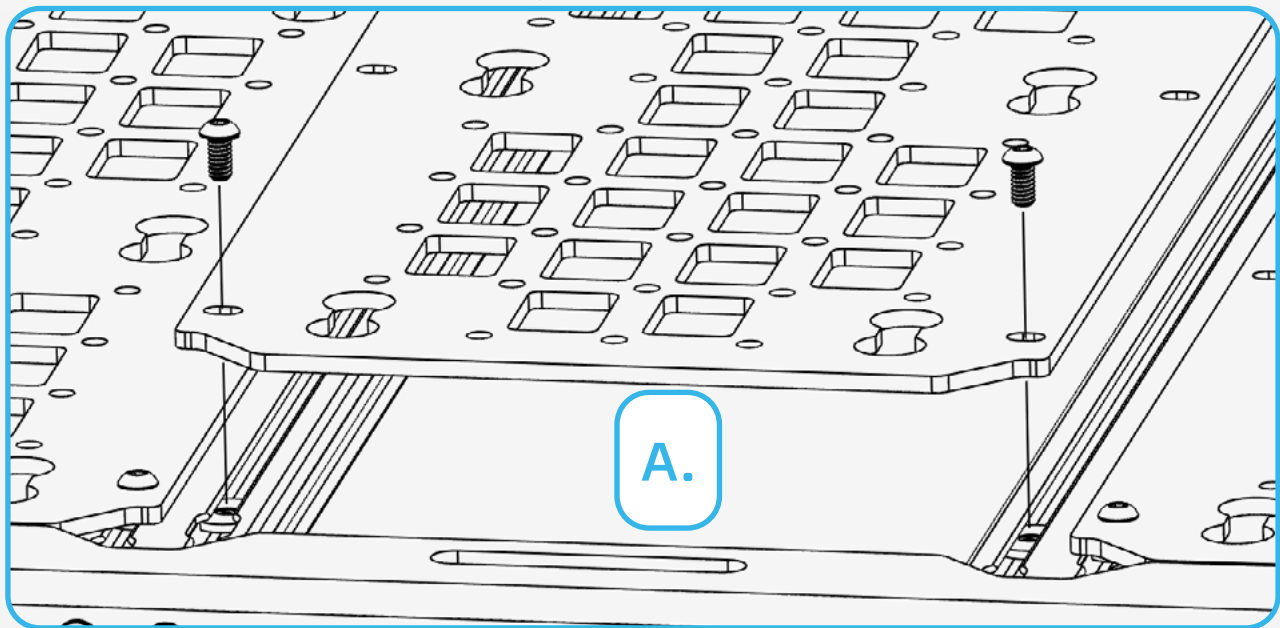
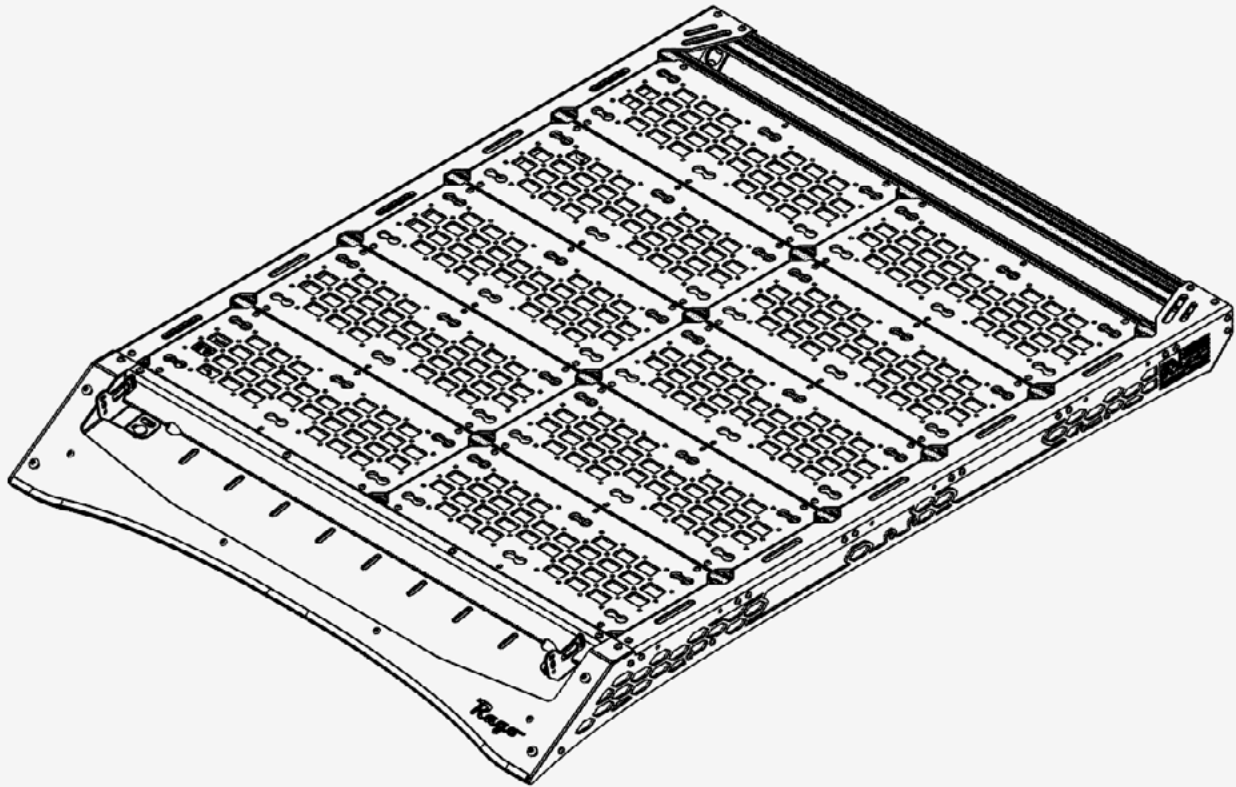

## STEP 3

Stand back and enjoy your new RAGO Deck Panels.

Check and re-tighten, if needed, all mounting bolts after 100 miles and periodically thereafter.

